

ALL RIGHTS RESERVED:

THIS DRAWING IS THE PROPERTY OF NORTH AMERICAN BULLET PROOF AND SHALL NOT BE REPRODUCED IN WHOLE OR PART. IT SHALL NOT BE USED FOR CONSTRUCTION OF OTHER THAN THE SPECIFIED PROJECT WITHOUT WRITTEN PERMISSION OF NORTH AMERICAN BULLET PROOF.

COMMENTS:

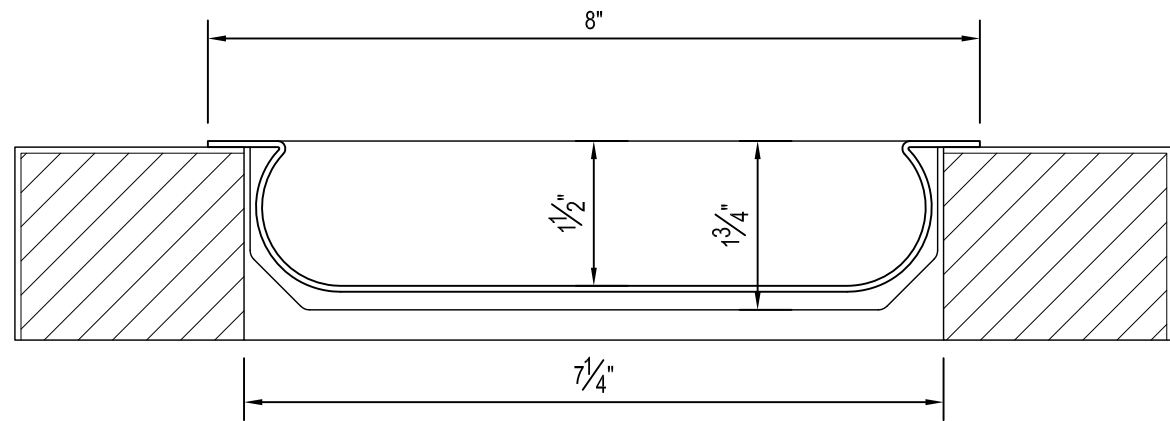

1 SECTION

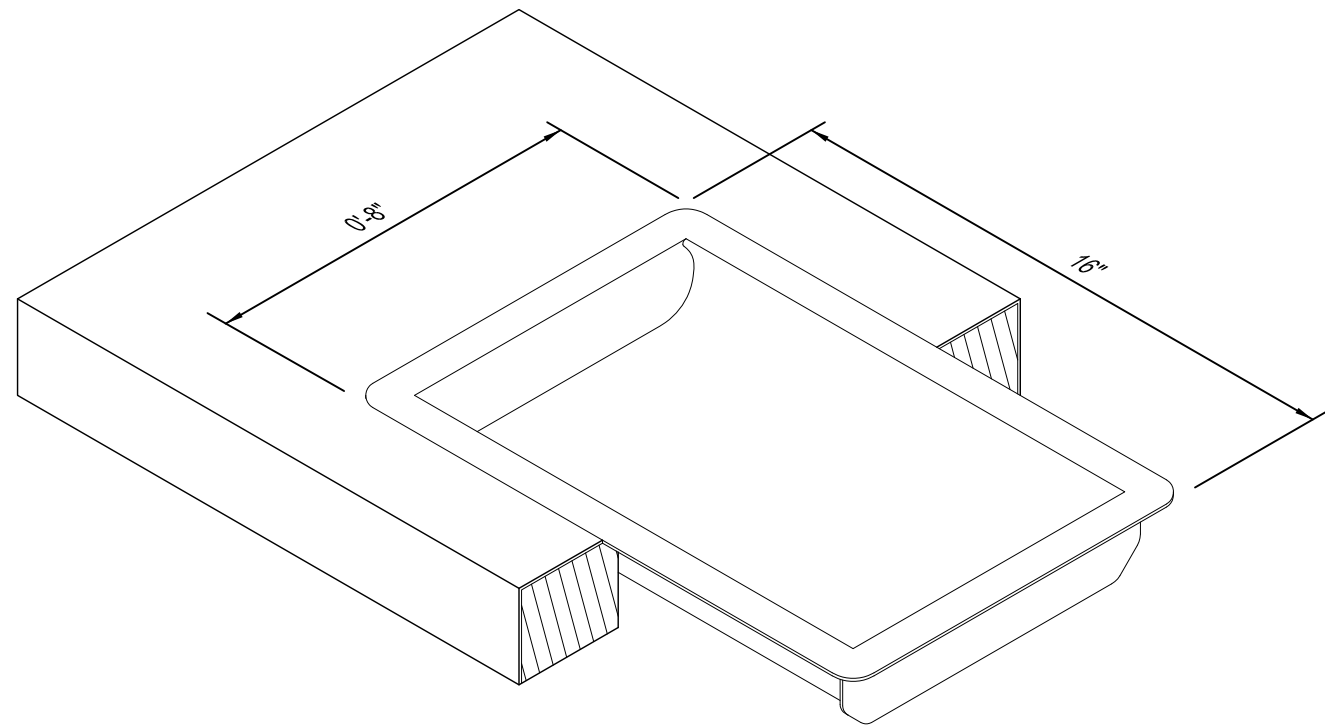

3 ISOMETRIC VIEW

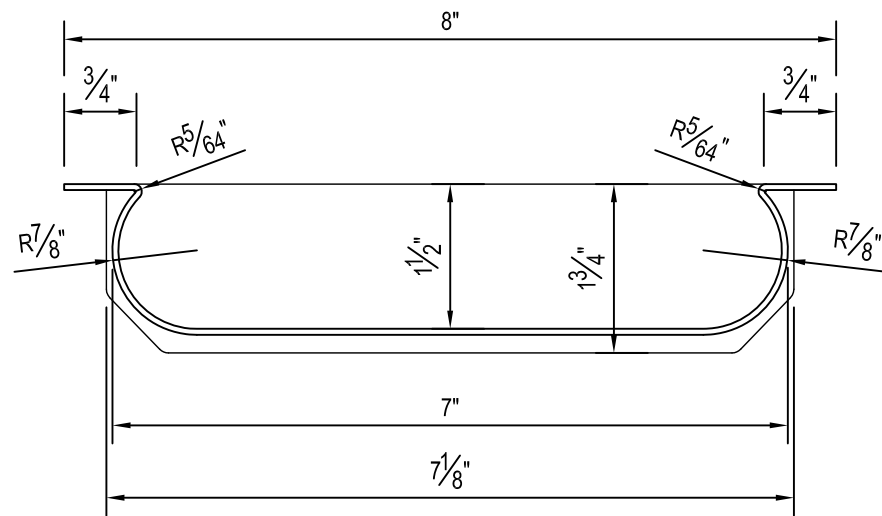

2 SECTION

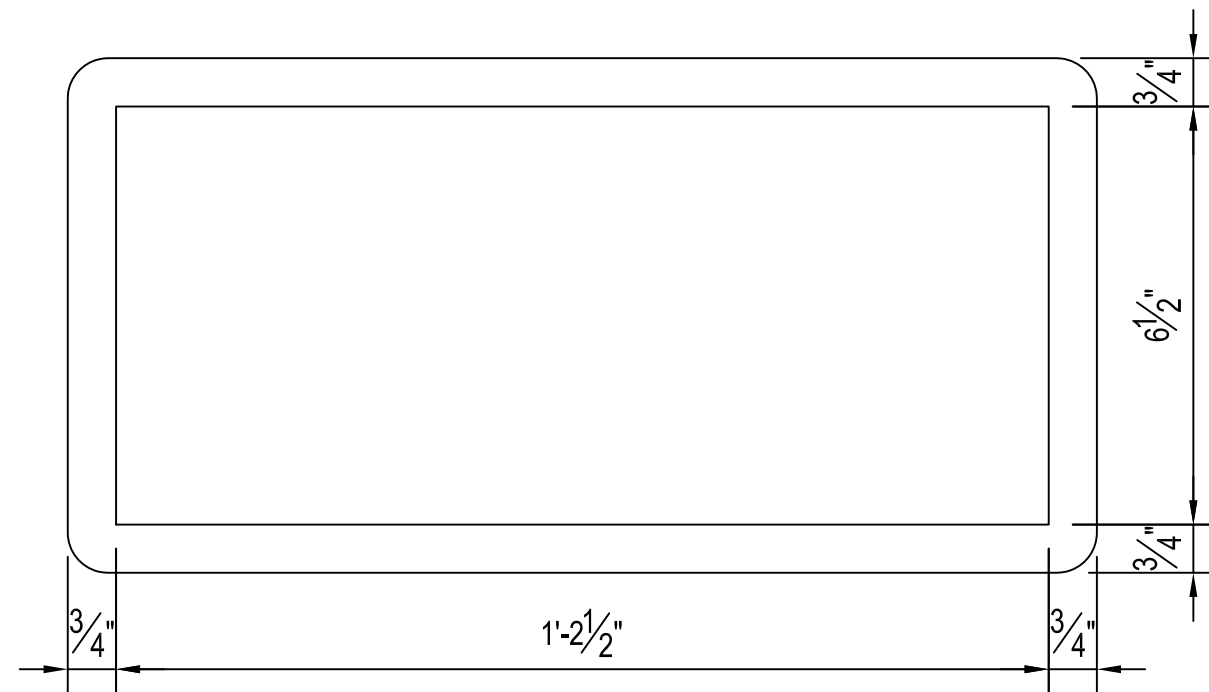

4 PLAN VIEW

NOTES

1. MATERIAL: 18 GA. STAINLESS STEEL
2. REQUIRED ROUGH OPENING 7 1/4" x 15 1/4"
3. MOUNTING DEPTH: 1 3/4"

MDT816NR
DEAL TRAY