

ALL RIGHTS RESERVED:

THIS DRAWING IS THE PROPERTY OF NORTH AMERICAN BULLET PROOF AND SHALL NOT BE REPRODUCED IN WHOLE OR PART. IT SHALL NOT BE USED FOR CONSTRUCTION OF OTHER THAN THE SPECIFIED PROJECT WITHOUT WRITTEN PERMISSION OF NORTH AMERICAN BULLET PROOF.

COMMENTS:

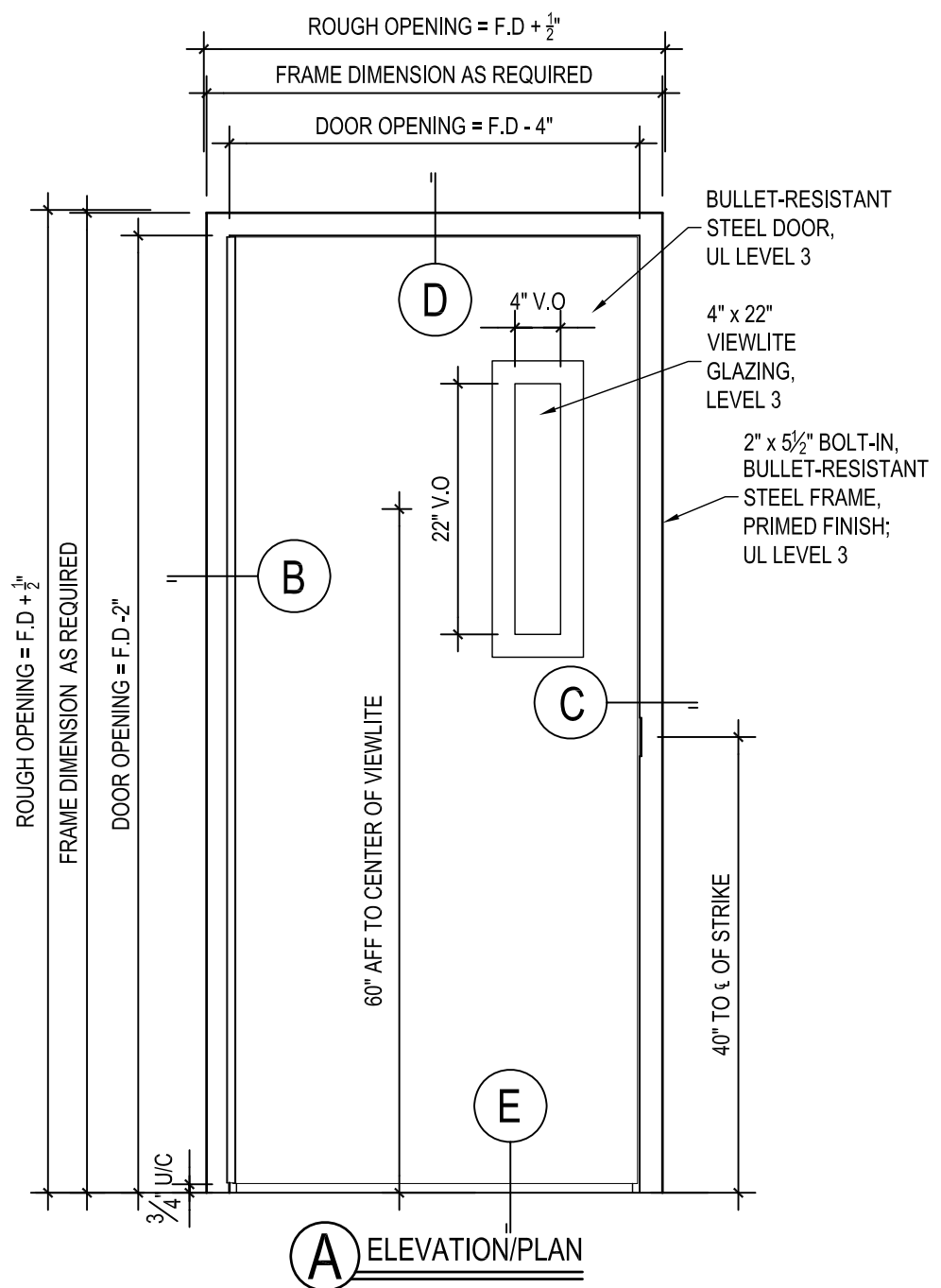
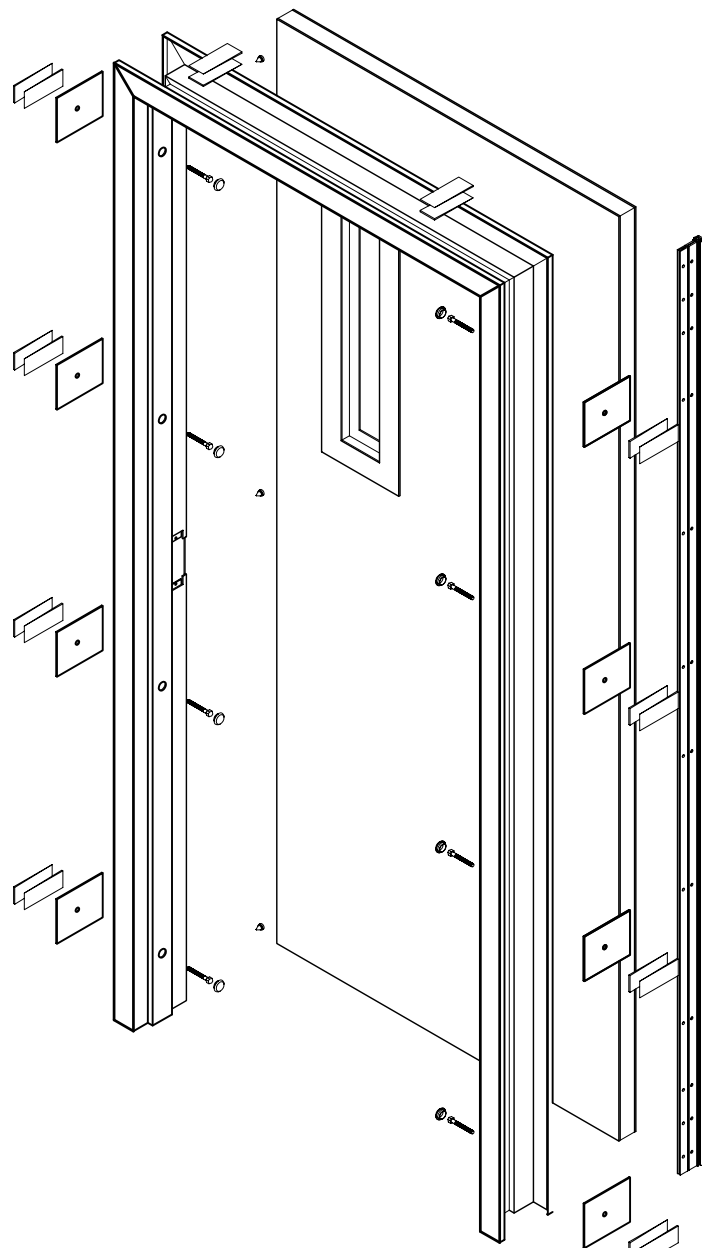

KEYNOTES:

- 02-1 2" x 5-1/2" BOLT-IN DOORFRAME: 12 GA. STEEL, PRIMED FINISH; UL LEVEL 3
- 02-3 4-3/4" x 4" ANCHOR PLATE: 12 GA. STEEL, PRIMED FINISH
- 02-7 CONTINUOUS -GEAR HINGE WITH SECURITY PINS
- 02-8 PRIMED FINISH STEEL DOOR WITH 4X22 VIEWLITE, UL LEVEL 3
- 01-1 DECORATIVE ANCHOR-HOLE PLUG
- 01-3 TYPICAL WALL CONSTRUCTION (BY OTHERS)
- 01-4 ANCHOR, AS REQUIRED (BY OTHERS)

