

ALL RIGHTS RESERVED:

THIS DRAWING IS THE PROPERTY OF NORTH AMERICAN BULLET PROOF AND SHALL NOT BE REPRODUCED IN WHOLE OR PART. IT SHALL NOT BE USED FOR CONSTRUCTION OF OTHER THAN THE SPECIFIED PROJECT WITHOUT WRITTEN PERMISSION OF NORTH AMERICAN BULLET PROOF.

COMMENTS:

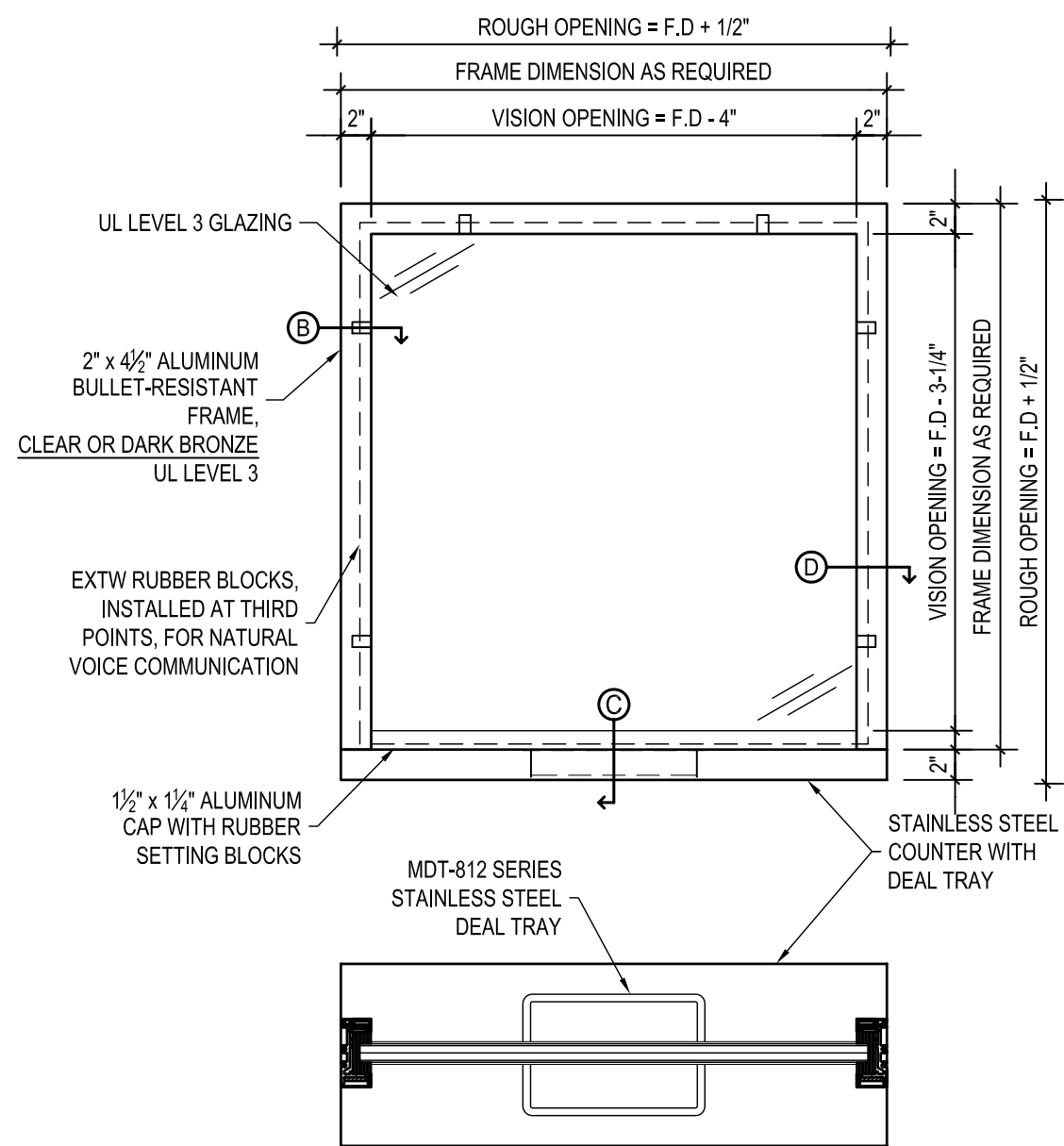
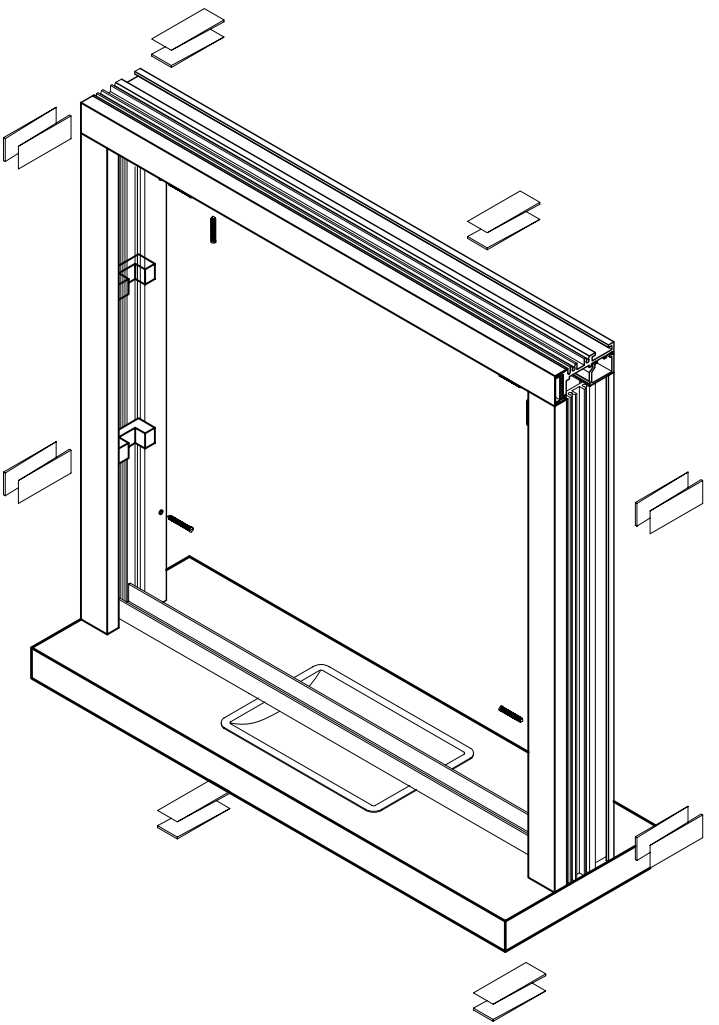

A ELEVATION/PLAN

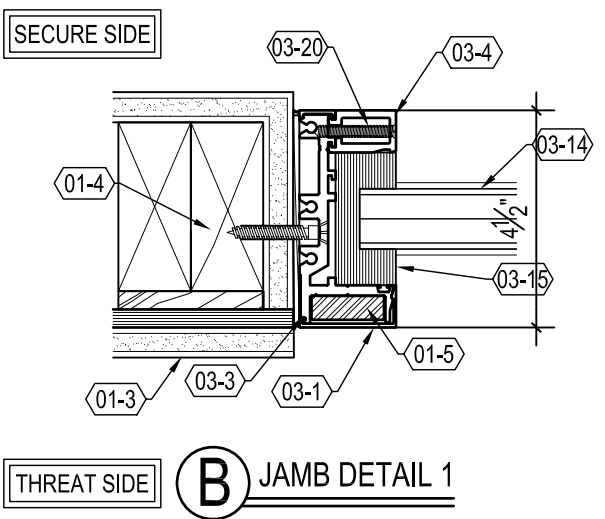

B JAMB DETAIL 1

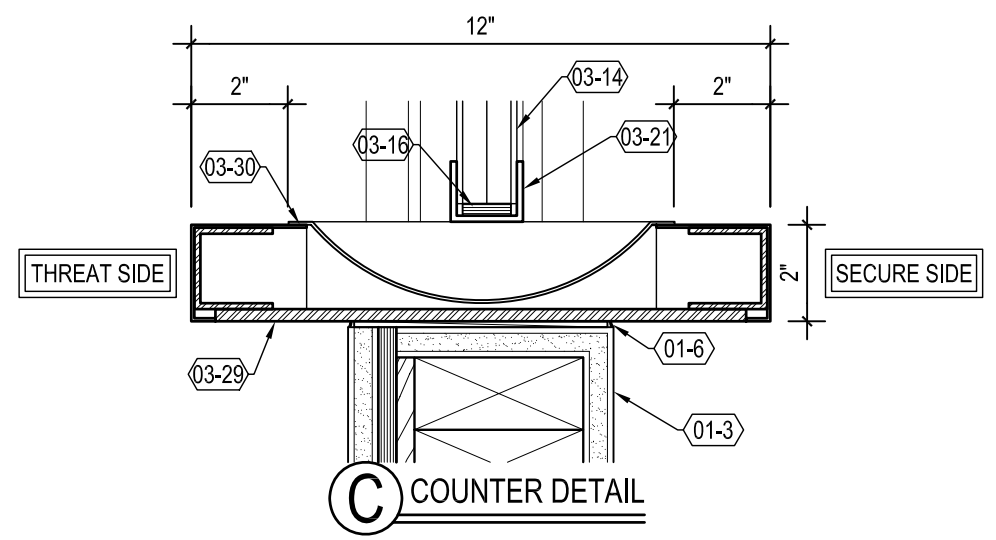

C COUNTER DETAIL

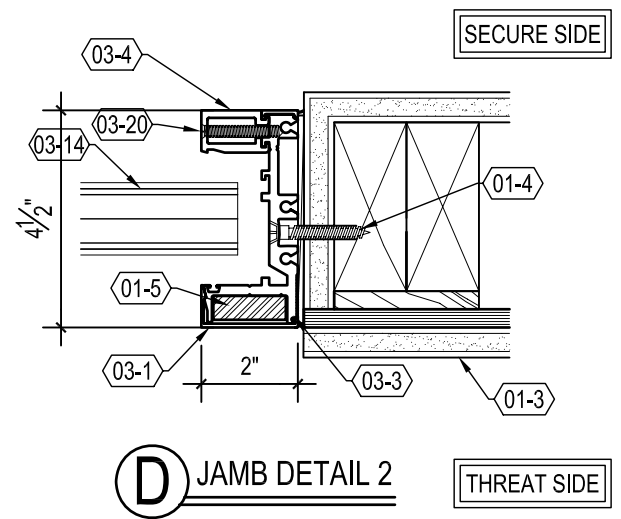

D JAMB DETAIL 2

KEYNOTES:

- 03-1 2" x 4-1/2" ALUMINUM BOLT-IN FRAME; CLEAR OR DARK BRONZE; UL LEVEL 4
- 03-4 GS 78 ALUMINUM STOP; CLEAR OR DARK BRONZE
- 03-14 UL LEVEL 4 GLAZING
- 03-15 EXTW RUBBER BLOCK
- 03-20 MOUNTING SCREW
- 03-21 1-1/2" x 1-1/4" ALUMINUM CAP @ EXPOSED GLAZING EDGE
- 03-29 STAINLESS STEEL COUNTER
- 03-30 MDT-812 SERIES STAINLESS STEEL DEAL TRAY
- 01-3 TYPICAL WALL CONSTRUCTION (BY OTHERS)
- 01-4 ANCHOR, AS REQUIRED (BY OTHERS)
- 01-5 BULLET-RESISTANT ARMOR, UL LEVEL 4