

NABP
P.O BOX 628
106 GUADALUPE DRIVE
CIBOLO TX, 78108
PHONE # (210) 225-0982
FAX # (210) 225-0984
WEBSITE: www.nabulletproof.com

ALL RIGHTS RESERVED:

THIS DRAWING IS THE PROPERTY OF NORTH AMERICAN BULLET PROOF AND SHALL NOT BE REPRODUCED IN WHOLE OR PART. IT SHALL NOT BE USED FOR CONSTRUCTION OF OTHER THAN THE SPECIFIED PROJECT WITHOUT WRITTEN PERMISSION OF NORTH AMERICAN BULLET PROOF.

COMMENTS:

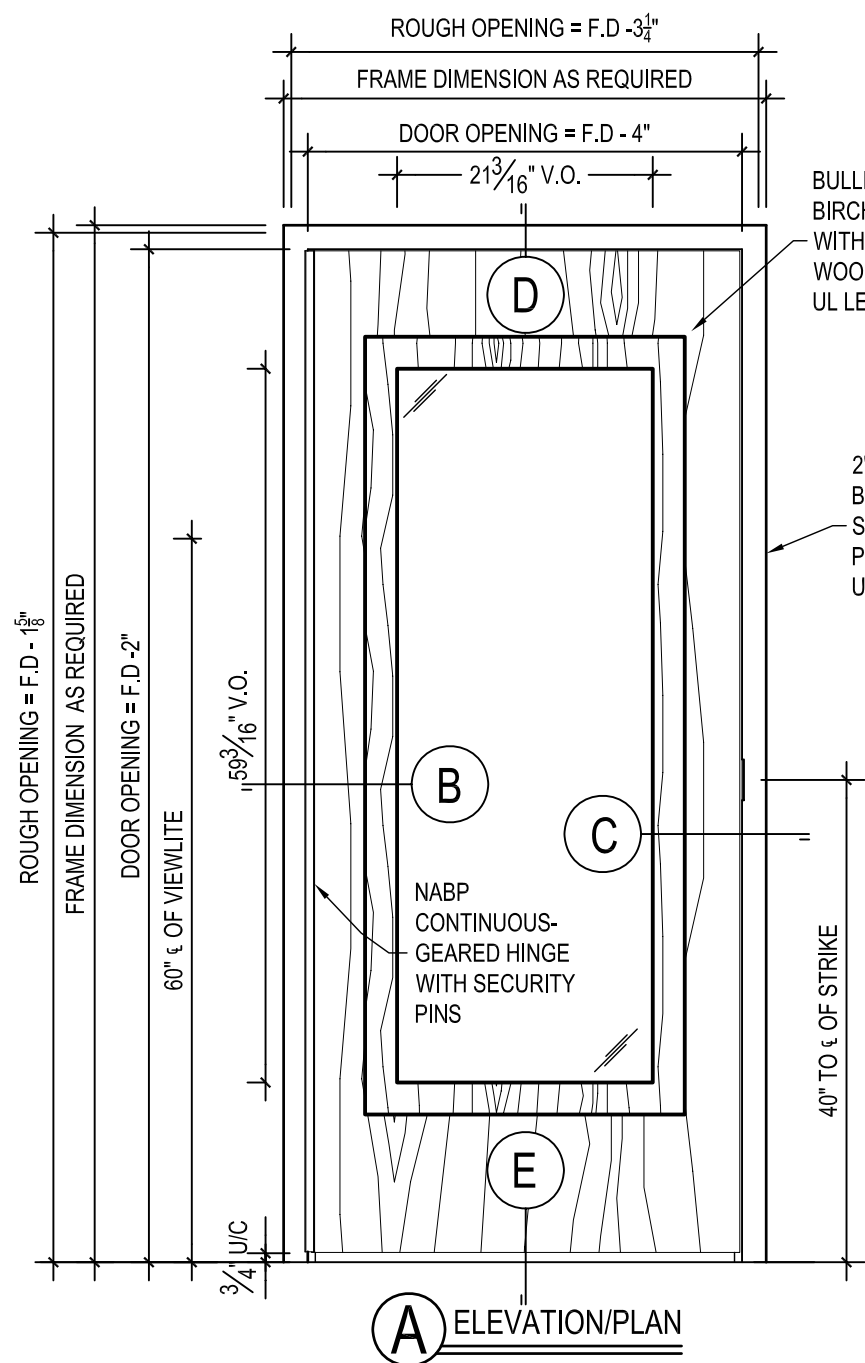
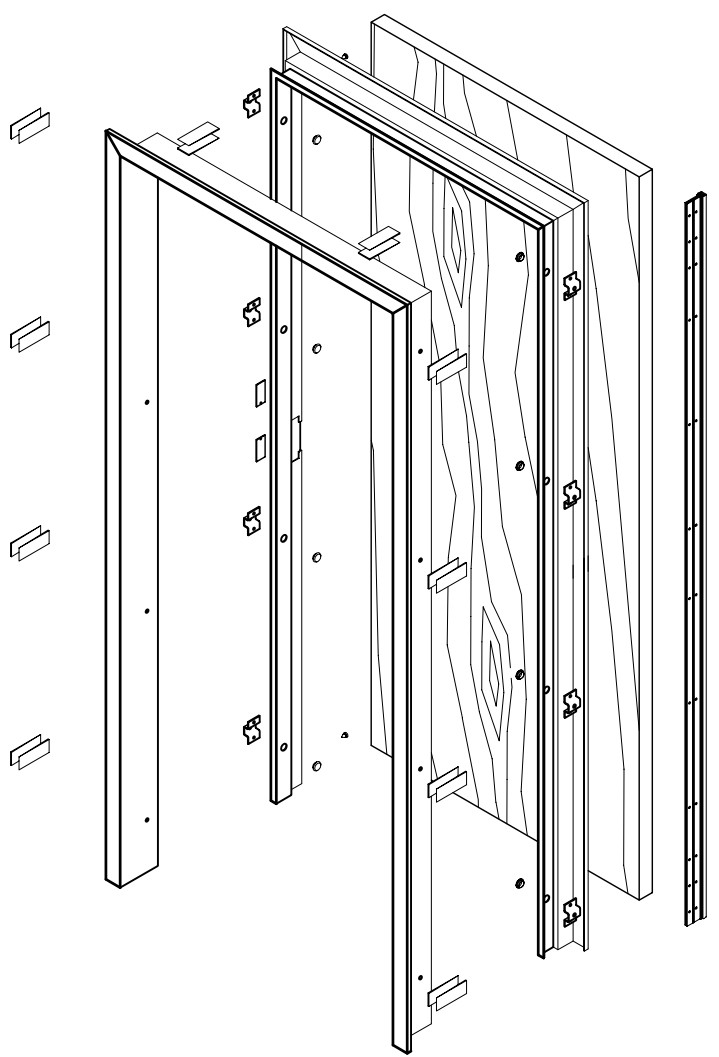

KEYNOTES:

- (02-1) 2" x ??? CLAMP DOORFRAME: 12 GA. STEEL, PRIMED FINISH; UL LEVEL 4
- (02-3) 12 GA. STEEL ANCHOR PLATE
- (02-7) CONTINUOUS -GEAR HINGE WITH SECURITY PINS
- (02-8) BULLET-RESISTANT UNFINISHED BIRCH OR RED OAK VENEERED WOOD DOOR WITH 22X60 VIEWLITE, UL LEVEL 4
- (01-1) DECORATIVE ANCHOR-HOLE PLUG
- (01-3) TYPICAL WALL CONSTRUCTION (BY OTHERS)
- (01-4) ANCHOR, AS REQUIRED (BY OTHERS)
- (01-5) BULLET RESISTANT ARMOR, UL LEVEL 4 (WHERE REQUIRED)

